

DOORSENSE

MAKE IT
UNION



...The safe, legal and easy way to
hold open a fire door



ASSA ABLOY

Trusted by **Professionals**

ASSA ABLOY, the global leader
in door opening solutions

Quality, Reliability, Expertise...
...three solid reasons to choose UNION

UNION quality

Achieving the perfect combination of technology and materials, each and every one of our products is manufactured to the highest specification – resulting in a quality of product that others can only aspire to.



UNION reliability

All of our products undergo the most rigorous testing – way beyond normal UK standards – in order to guarantee the longest lifetime of excellent performance.

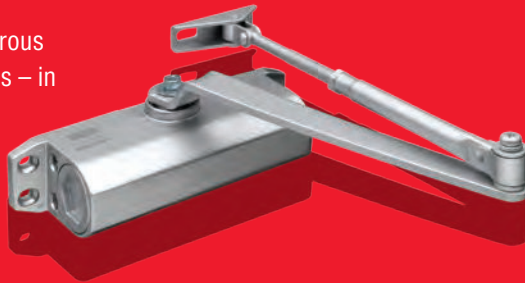

UNION expertise

Established as a manufacturer back in 1840, our expertise and heritage is second to none and combined with ASSA ABLOY's dedication to research and development - you can be confident that you're fitting a product you can trust.

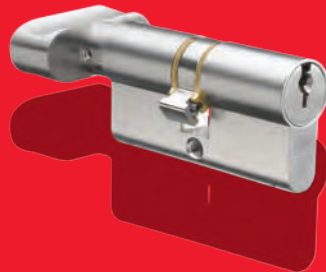

Don't take risks with your fire safety



A fire door won't work if it is propped open with wedges or furniture.

Stopping a fire door from closing can put your insurance at risk – and land you in court if a fire takes hold.

Any fire door that is kept open without a device to release it in the event of a fire alarm activating could lead to legal action under the Regulatory Reform Fire Safety Act 2006 and Health And Safety at Work Act 1974.

Now there is a way for you to keep a fire door open for easy access - and have it close if the alarm sounds and at a set time.

DoorSense from UNION is the easiest way for your fire door to give easy access and remain an effective barrier to smoke and fire.

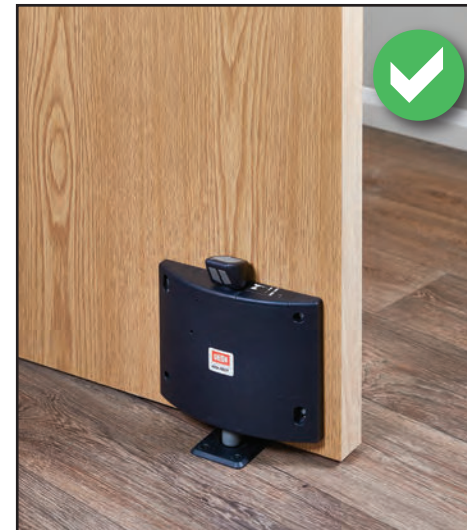

DoorSense is a standalone, battery-powered unit which can be fixed to a fire door in seconds to provide a reliable way to keep it open – but will automatically release if the fire alarm sounds.

DoorSense is incredibly easy to install, needing no wiring or special skills. Just use the template provided – and can even use the same footprint as other units

Once installed you can have DoorSense working manually - using the foot release or by pushing the door away from the frame - or automatically using the pre-set night release timer.

DoorSense - the sensible solution to fire door access and safety



UNION DoorSense holds your fire doors open, improving access around your building. If the fire alarm sounds, DoorSense automatically releases to let the door close.*



CE Marked to EN 1155, EMC tested and fire rated for timber doors (FD120) - legally allows fire doors to be held open for easier access.



Sound tested over 50,000 times - beyond legal standards, so you can depend on it working.



Quick and easy to install with no secondary installation costs, such as electrical wiring, and retro fits existing products.

Make the right choice... make it UNION.

For further information please visit www.uniononline.co.uk/doorsense or contact us on 0845 223 2124

*A separate door closer must be installed. Visit www.uniononline.co.uk to find the perfect door closer for your fire door. It is recommended DoorSense is used in conjunction with a professionally installed fire alarm system.



Batteries and fixings are included.

Reasons to choose

DOORSENSE

Safe

- Unlike a door wedge, DoorSense releases an open door when the fire alarm sounds, allowing it to be closed.
- CE Marked to EN 1155 and fire rated (FD120) for use on timber doors to give installers and end users peace of mind.

Simple

- Easy to install - no wiring or specialist skills needed. Simple, clear instructions with a template provided. Watch our guide at www.uniononline.co.uk/doorsense
- Low maintenance costs - powered by two C-type batteries (included) with charge indicator for peace of mind.
- Can be released manually, by sound or with the built-in timer at a pre-set time.



Versatile

- Ideal for any large or small applications where fire doors are installed including care homes, schools, public buildings, etc.
- Available in black, red or white.
- Retro fits the footprint of existing products.
- Designed to stay working longer, with a robust, rounded casing deflecting impacts.



Features and Specification

Product Code
J-8755A-BLACK
J-8755A-RED
J8755A-WHITE

- Acoustic release door hold open device
- Suitable for use in conjunction with size 3 to size 7 door closers
- Suitable for doors up to 160Kg and 1600mm width
- CE Marked to EN 1155 and EMC tested 
- Fire rated for timber (FD120) fire doors 
- 2 year guarantee for peace of mind 
- Powered by 2xC alkaline batteries which are included
- Low battery indicator
- Timer can be set to automatically release DoorSense
- Release sensitivity can be adjusted to suit your environment
- Automatically releases with sounds greater than 80dB and longer than 15 seconds
- Fail safe mode automatically releases DoorSense
- Curved shape to deflect impacts and help prolong working life
- Please visit www.uniononline.co.uk/dop for declaration of performance documentation

Product Dimensions

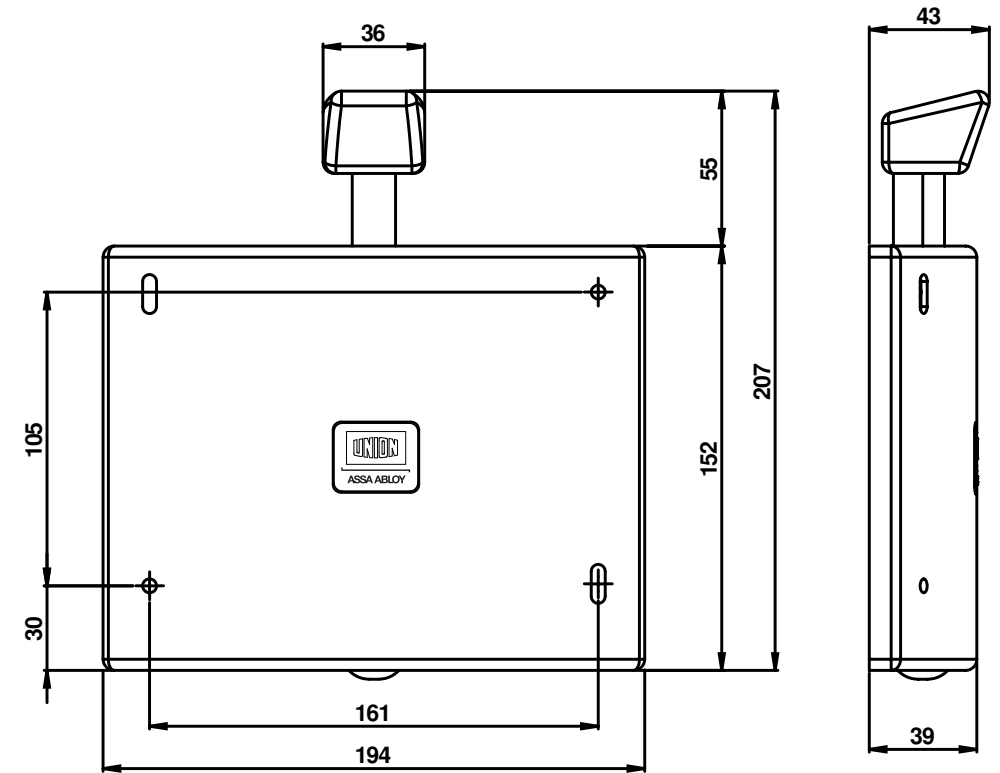

All dimensions are in millimetres

DoorSense can be retrofitted over previously installed door release units.

For further product information and installation video, please visit www.uniononline.co.uk/doorsense

**For further details on this or any of
the products in the UNION range please contact your
Regional Sales Manager or the Customer Services Department:**

ASSA ABLOY Security Solutions
School Street, Willenhall WV13 3PW
Tel: 0845 223 2124 Email: info@uniononline.co.uk
www.uniononline.co.uk/doorsense

Version 1 March 2017



ASSA ABLOY

ASSA ABLOY, the global leader
in door opening solutions

Trusted by **Professionals**